

1

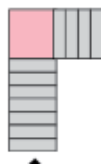

2

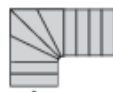
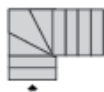

3

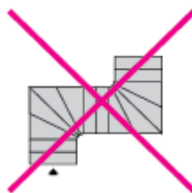
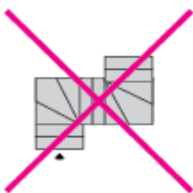
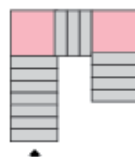
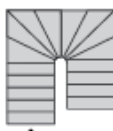

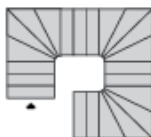
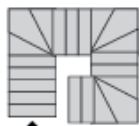

4

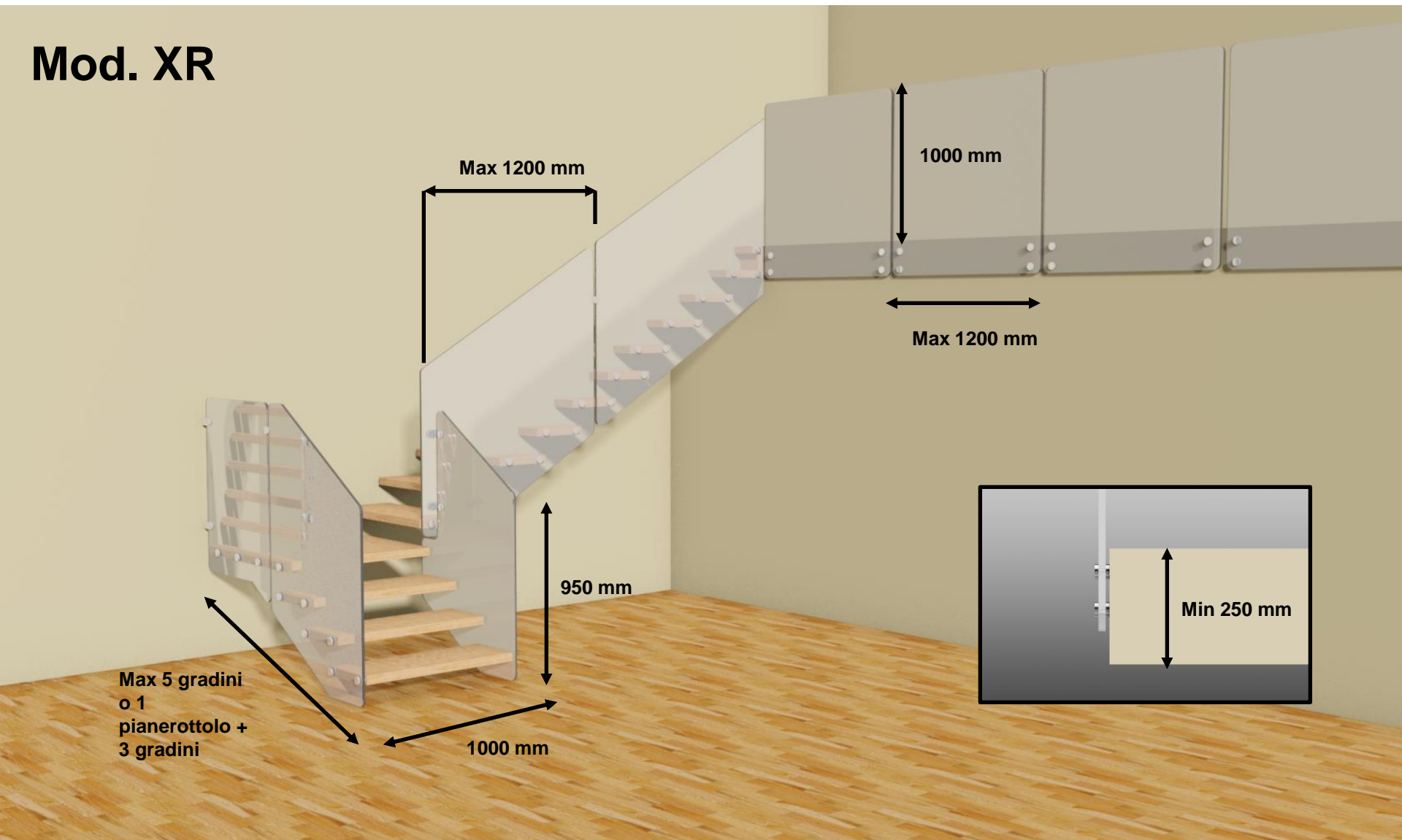

Mod. XR

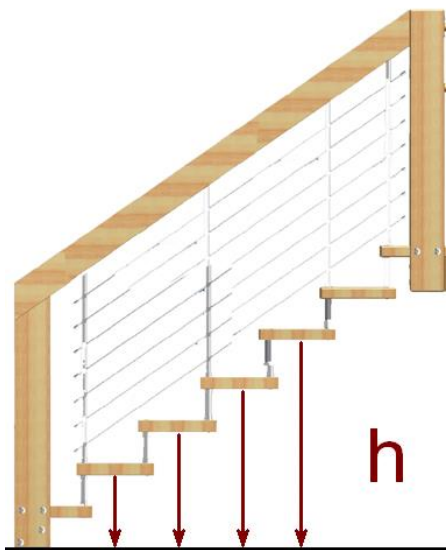



|  | G3 | G4 | G5 | G6 | G7 | G8 | G9 | G10 | G11 | G12 | G13 | G14 | G15 |
|---|-----|-----|------|------|------|------|------|------|------|------|------|------|------|
| 170 | 460 | 630 | 800 | 970 | 1140 | 1310 | 1480 | 1650 | 1820 | 1990 | 2160 | 2330 | 2500 |
| 180 | 490 | 670 | 850 | 1030 | 1210 | 1390 | 1570 | 1750 | 1930 | 2110 | 2290 | 2470 | 2650 |
| 190 | 520 | 710 | 900 | 1090 | 1280 | 1470 | 1660 | 1850 | 2040 | 2230 | 2420 | 2610 | 2800 |
| 200 | 550 | 750 | 950 | 1150 | 1350 | 1550 | 1750 | 1950 | 2150 | 2350 | 2550 | 2750 | 2950 |
| 210 | 580 | 790 | 1000 | 1210 | 1420 | 1630 | 1840 | 2050 | 2260 | 2470 | 2680 | 2890 | 3100 |
| 220 | 610 | 830 | 1050 | 1270 | 1490 | 1710 | 1930 | 2150 | 2370 | 2590 | 2810 | 3030 | 3250 |
| 230 | 640 | 870 | 1100 | 1330 | 1560 | 1790 | 2020 | 2250 | 2480 | 2710 | 2940 | 3170 | 3400 |
| 240 | 670 | 910 | 1150 | 1390 | 1630 | 1870 | 2110 | 2350 | 2590 | 2830 | 3070 | 3310 | 3550 |
| 250 | 700 | 950 | 1200 | 1450 | 1700 | 1950 | 2200 | 2450 | 2700 | 2950 | 3200 | 3450 | 3700 |

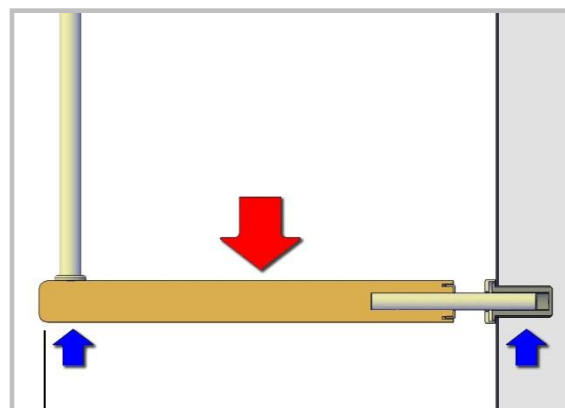

500 ÷ 950

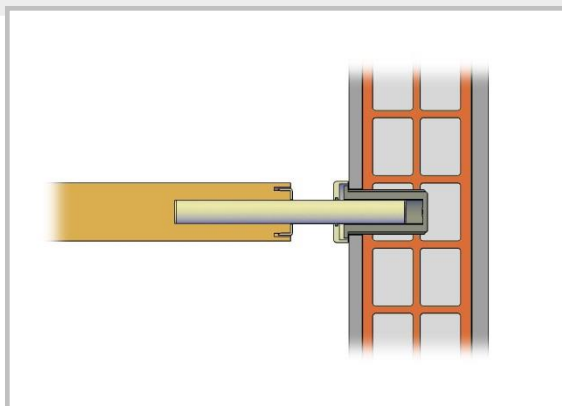
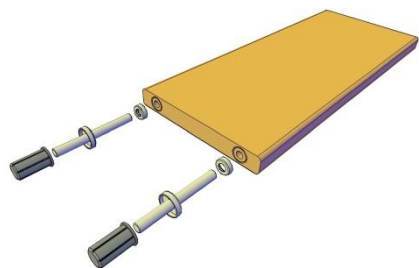

Tramezza
Partition wall
Cloison
Nicht Tragend Wand

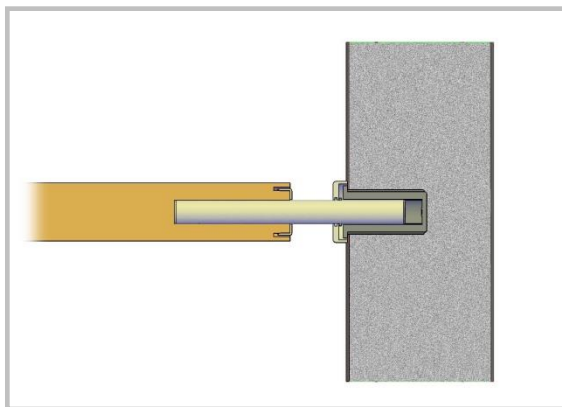
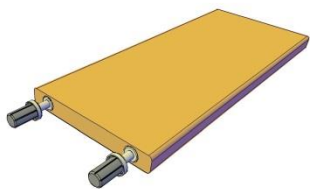

Portante
Bearing Wall
Mur portant
Hauptmauer

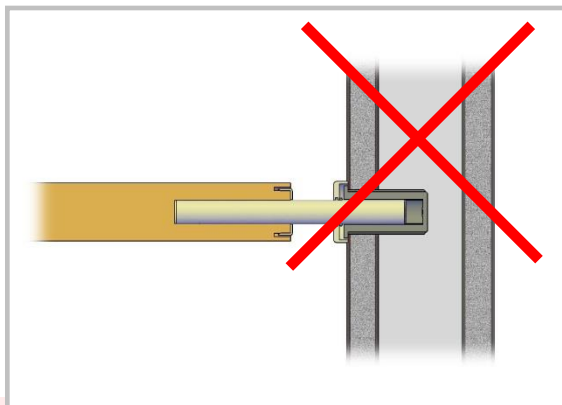
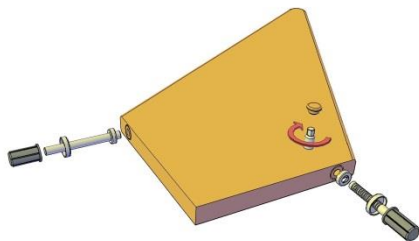

Cartongesso
Plaster board
Placoplâtre
Gipspappe

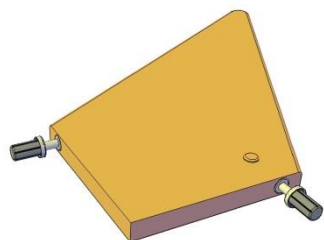

| G10 | G11 | G12 | G13 | G14 | G15 | G16 | G17 |
|------|------|------|------|------|------|------|------|
| h | h | h | h | h | h | h | h |
| 1870 | 2040 | 2210 | 2380 | 2550 | 2720 | 2890 | 3060 |
| 2750 | 3000 | 3250 | 3500 | 3750 | 4000 | 4250 | 4500 |

